



Kylin[®]
SAUNA

Kylin Sauna Instruction Manual



At Kylin Infrared Saunas, our vision is to transform lives by providing exceptional infrared sauna experiences that promote physical rejuvenation and mental revitalization.

Thank you so much for purchasing the Kylin Infrared Sauna! Please take the time to carefully read through this manual. Keep this manual and your proof of purchase for future reference and service calls. Welcome to reach our team if you have any questions about your infrared sauna!

You can scan the below QR code to download a digital Kylin sauna instruction manual.



Table of Content

TABLE OF CONTENT.....	4
SAFETY INSTRUCTIONS.....	5
ELECTRICAL REQUIREMENTS	6
INSTALLATION INSTRUCTIONS.....	7
STRUCTURE AND COMPONENTS	8
GENERAL GUIDE FOR INDOOR SAUNA.....	10
ACCESSORIES (PROVIDED FOR SPECIFIED MODELS ONLY)	19
CONTROL PANEL OPERATION INSTRUCTIONS	21
USAGE GUIDE	27
A REMINDER WHEN HAVING YOUR SAUNA	28
SAUNA BENEFITS	31
SAUNAS AND CONTRAINDICATIONS.....	32
TROUBLESHOOTING.....	35
WARRANTY INFORMATION.....	38

Safety instructions

1. **Excessive sweating may cause stains on wood and damage to electrical appliances. Please use one or two towel placed on the bench and on the floor heater to absorb sweat when using the sauna.**
2. **The indoor sauna room is not waterproof, please do not spray water on the sauna room, and keep away from any water source.**
3. Indoor saunas should be placed under an awning or sheltered area even when using a sauna cover.
4. Do not use liquid cleaners or aerosol cleansers on the interior or exterior of the sauna. Only use a damp cloth for cleaning.
5. Use of chemicals will damage the wood and any natural protection layer inherent in the wood.
6. To reduce the risk of injury, do not allow children to use the sauna unless they are closely supervised at all times.
7. Persons with health conditions or using medications should consult their physicians before using sauna.
8. Excessive temperatures have a high potential for causing fetal damage during the early months of pregnancy. Pregnant or possibly pregnant women should contact their physician prior to using the sauna.
9. Persons using medications should consult a physician before using the sauna since some medications may induce drowsiness while others may affect heart rate, blood pressure, and circulation.
10. Please exit immediately if you feel uncomfortable, dizzy or sleepy.
11. Remove all jewelry before you enter the sauna.
12. Never sleep inside the sauna while the unit is in full operation.
13. Do not attempt any repair without consulting the manufacturer first. Unauthorized repair attempts will void manufacturer's warranty.

WARNING: The use of alcohol, drugs, or medications prior to or during the sauna session may lead to unconsciousness.

Electrical Requirements

Please follow all instructions carefully. Each sauna will require a dedicated circuit when plugged in an outlet according to the image below. A dedicated circuit requires that no other appliance should share the outlet/circuit with the sauna. Failure to comply with this requirement may cause electrical interruption and diminished performance. It is recommended that a qualified electrician install an extra dedicated electrical socket for proper sauna functionality and to avoid any potential electrical hazards. Please make sure the sauna is properly grounded. Serious injury may result if proper electrical requirements are not met. Should you have any questions, please do not hesitate to contact Kylin Sauna support team.

Power Plug

Standard domestic 10A plug

***Please use a dedicated wall socket for the sauna and do not share it with other electrical devices.**



Installation Instructions

Please read the following directions carefully. The sauna installation may require a minimum of 2 people. You should not try to install the sauna on your own as damage will easily occur.









Caution

- 1- No plumbing or plumbing fixtures should be placed in the sauna.
- 2- Install the sauna on a completely level surface.
- 3- Keep all liquids away from the heating panels.
- 4- Keep the sauna away from any potential hazards including any water source or liquids. Select a dry suitable location for the sauna installation.
- 5- **Indoor sauna room is best placed indoors such as bathroom, pool area, or it can be placed outdoors where only fully covered areas, such as on a deck, terraces or balconies to protect it from the rain, moisture and other elements in order to maintain the naturally untreated Canadian Hemlock finish.**
- 6- Do not expose the heater elements to any water source or liquids as it may cause electrical shock.
- 7- Flammable objects and corrosive chemical substances should be kept far away from the sauna.
- 8- Do not plug any other appliances into the outlet sharing with the infrared sauna.

Your infrared sauna will come packaged **in one or more boxes**. Please make sure that you open the boxes face up. And be mindful of the fragile parts and glass enclosed during the opening process.

Structure and Components

Below are pictures of each panel for the 2-person model. Other models vary.

Front Panel	Bottom Panel
	
Top Panel	Back Panel
	
Left Panel	Right Panel
	
Bench Panel	Bench Heater Panel
	

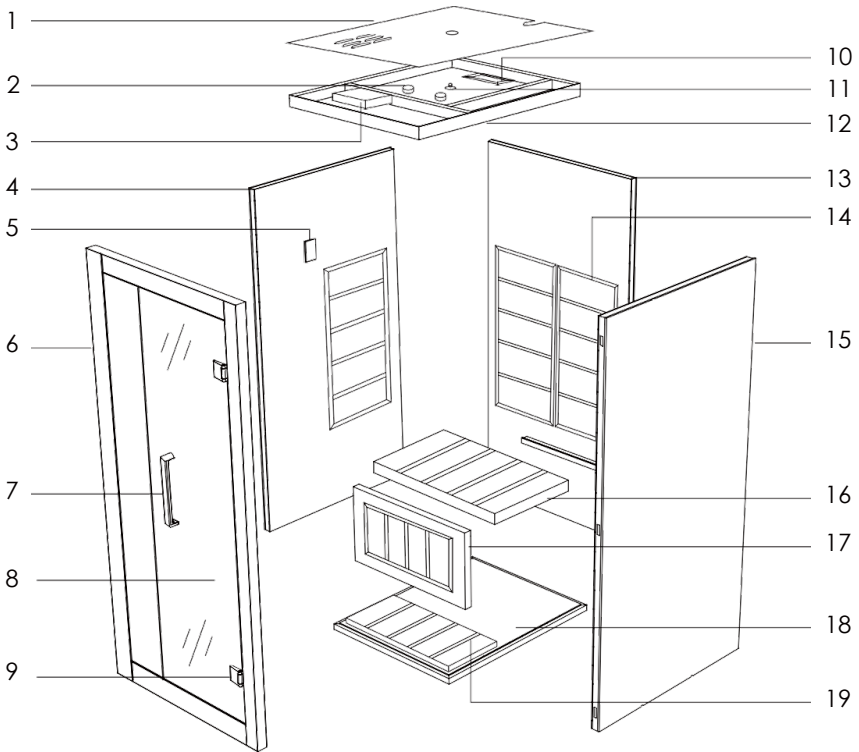

- | | | | |
|-----------------|----------------|-----------------------|----------------------|
| 1 Duster cover | 6 Front board | 11 Temperature sensor | 16 Bench |
| 2 Speaker | 7 Handle | 12 Top board | 17 Bench front board |
| 3 Control box | 8 Door glass | 13 Back board | 18 Bottom board |
| 4 Left board | 9 Hinge | 14 Heater frame | 19 Foot rest board |
| 5 Control panel | 10 Ventilation | 15 Right board | |

*The structure may vary from different models

General Guide for Indoor Sauna

This installation is a general instruction for most of the models, the structure may vary from different models. Please refer to the correct article for a specified model.

1. Where to Start

Lay the boxes flat on the ground and open them carefully. The accessories, user manual and smaller parts are located under the dust cover - the box that includes the top and bottom panels (Figure G-4).

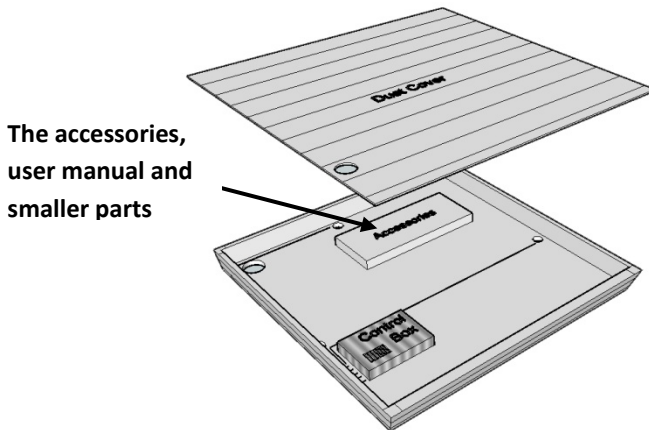

Figure G-4: Remove the Dust Cover to uncover the accessories

2. Floor Panel

Place the floor panel flat on the desired location. Make sure to leave a space around the side walls for one person to stand and install the side panels (Figure A-1). You can slide the sauna a bit once it's completely next to a wall.

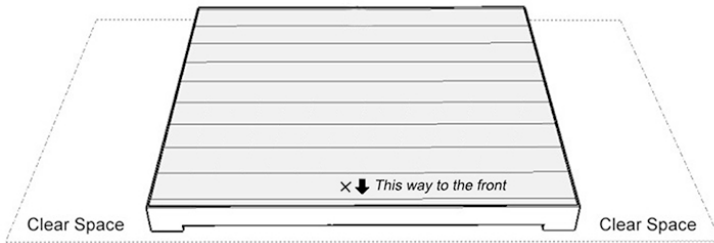

Figure A-1: Floor Panel

3. Rear Panel

Place the rear panel on the back end of the floor panel (Figure A-2). At this point, another person should hold the rear panel until the next connection is made.

4. Left Panel

Install the left panel as the image below. Make sure the top of both panels is flat and leveled.

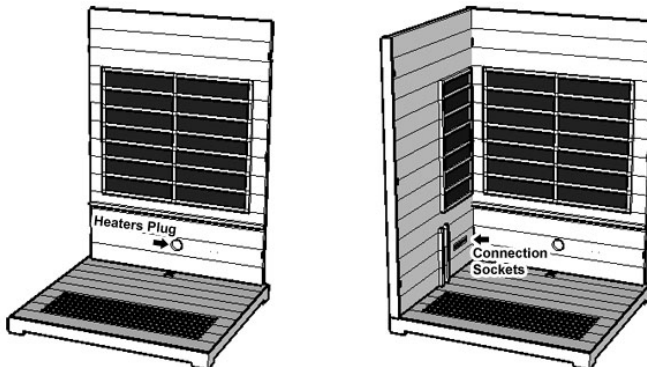

Figure A-2: Rear and left panels

5. Connecting the Panels:

Kylin Sauna offers **three types of panels locking systems to connect the sides of the different saunas depending on different models.** Please use the instructions below as a reference guide on how to connect the sauna panels. (Figure G-1)

A. Inner Locking System:

The inner locking system is designed to be completely invisible when the sauna is installed. The locks are built on the side of each panel and they connect by sliding one over the other (Figure G-2).

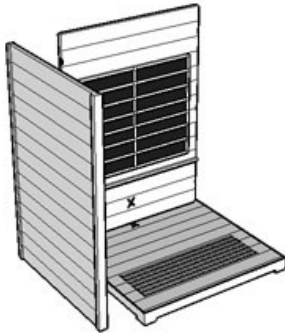

Align the panels

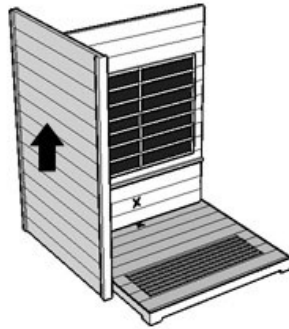

Lift the panel a few inches up

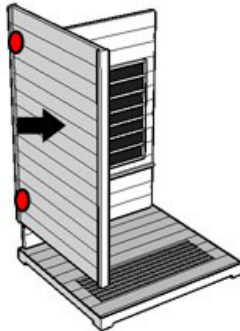

Push the panel forward

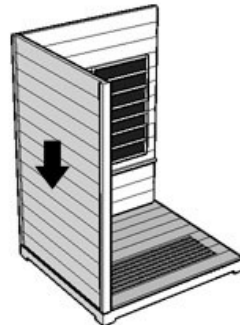

Slide down to lock panels

Figure G-1: Connect panels, inner lock system

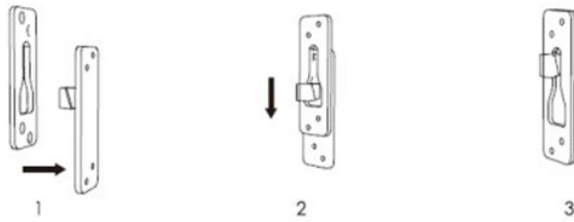

Figure G-2: Inner Locking System

To connect two panels, follow these few steps:

1. Lift the panel with the female locks a few inches up.
2. Push it against the opposite panel; make sure to apply pressure around the top and bottom corners.
3. Slide the panel down to lock it in place. Make sure all the locks are connected (top and bottom).
4. Inspect the panels and make sure they are leveled (the panels top is flat and matching).

B. Latch System:

The Latch Locking System is two buckles that lock together by passing the main loop over the opposite side and locking the latch (Figure G-3). When the back and side panel are all together on the floor, panel you can now close and latch it.

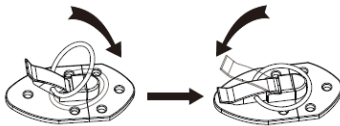

Figure G-3: Latch Locking System

C. Screwing System

Align two panels with corresponding battens, and then fasten the panels by screwing them tightly.

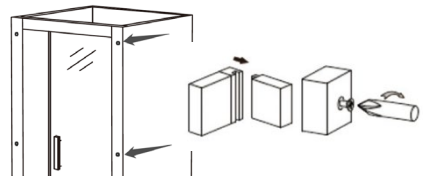

Figure G-3b: Screwing System

6. Seating Bench

Slide the bench stand panel between the two vertical guides on the side panels. Connect the heaters' plugs under the bench to the appropriate sockets. The matching plugs and sockets are labeled alphabetically – e.g., **connect “HT1” plug into the “HT1” socket**. There may be a spare plug or socket for the models for adding an extra floor heater.

Install the seating bench by placing it on top of the bench stand and the horizontal guide on the rear panel. Make sure the smooth and finished side is facing up and forward (Figure A-3).

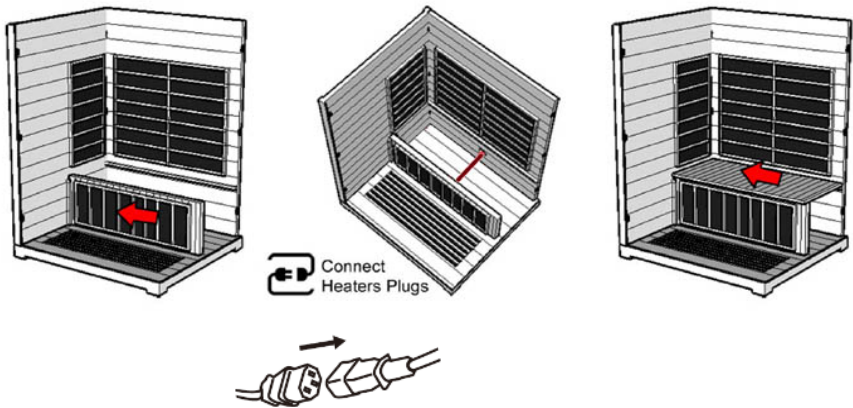

Figure A-3: Installing the Bench

7. Right Panel

Install the right panel as the image below (Figure A-4). Make sure the top of all the panels is flat and leveled.

Tip:

- A person can stand inside the sauna to match the bench stand with the vertical guide on the right panel and level the corners for easier installation. If the lower lock is not connecting, make sure the bench stand is not blocking the panel by aligning it with the vertical guide.

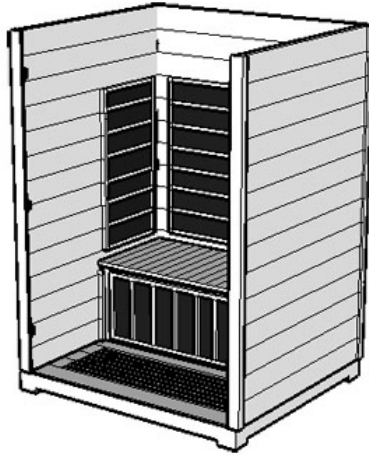

Figure A-4: Right Panel

- Install and secure the bench with screws if necessary.



8. Front Panel

Install the door handle before installing the front panel. Connect the front panel to both side panels as in the image below (Figure A-5).

Tips:

- Make sure to align the corners of the two side panels and the edges of the front panel.
- The front panel is heavy because of the glass door. At least two people are needed to lift it.
- **For the inner locking system**, a person can stand inside the sauna to align the edges and corners of the panels.
- **For the latch locking system**, latch the front panel with the left and right panels in the corners. Please take caution with the glass door.
- Please also make sure to put pressure on the top and bottom corners of each side to ensure the locks are connecting.

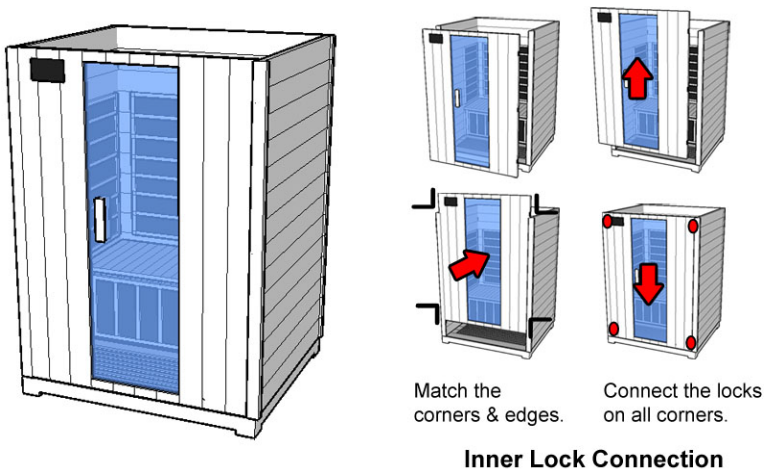
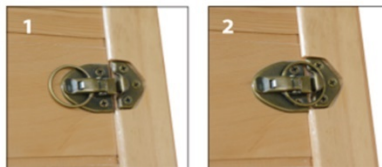

Figure A-5: Front Panel



9. Top Panel

- Raise the top panel over the sauna body. Put any wires from the front and back panels back into the center of the sauna cabinet to avoid pressing them when installing the internal top panel.
- While you are placing the internal top panel, **make sure all wires and connecting plugs are slipped through the corresponding holes of the internal top panel.** All these wires should be connected to the controller on the internal top panel. (Figure A-6).

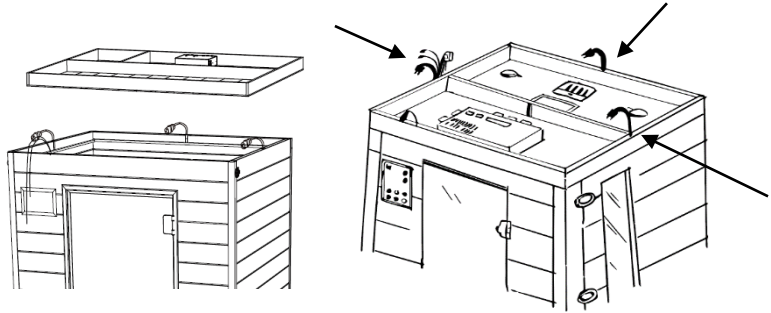
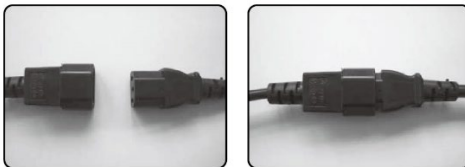

Figure A-6: Top Panel

Connect all the wires and connectors to the corresponding outlets on the internal top panel.

Tips:

- The two speaker wires (2-pin white)
- The control panel (CTRL in grey)
- The buzzer (black)
- The heating panel wires: “HT1” plug into the “HT1” socket, “HT2” to “HT2” and so on.
- Make sure connections are tight and secure.



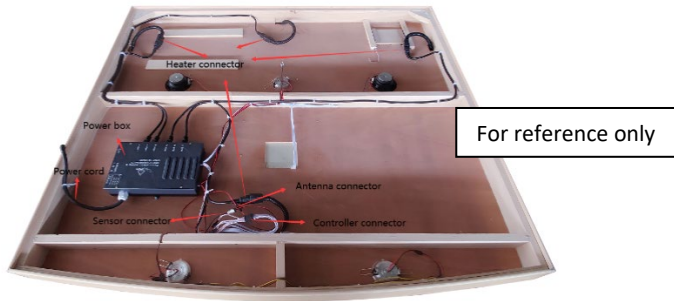

Place the dust cover over the sauna roof and pass the main power plug through the opening. Make sure to match the holes for the vent on the dust cover with the sauna vent holes. (Figure A-8)

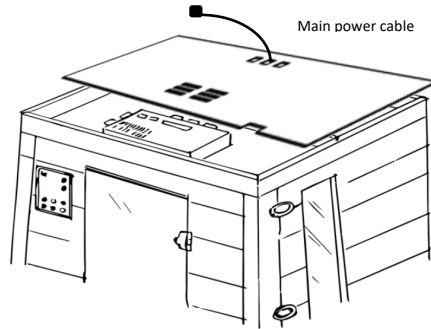

Figure A-8: Top Panels and Dust Cover

Optional Accessories such as wooden towel rails and magazine racks may be provided depending on the model. You can attach them to the side panels in your preferred location in the sauna. **For information on how to place accessories, see the "Accessories" section (page 26).**

Installation should now be complete. Plug in the power and turn the sauna on at the control panel.

- Installation Completed -

Accessories (Provided for specified models only)

The below accessories are optional and some models with glass front or all-round heaters or corner saunas will not include these accessories. They can be screwed on one of the side panels (either right or left, based on the user preference). Please do not install the holder and rack in front of the heaters.

Cup Holder (optional)

The cup holder is a small wooden shelf that can be mounted by screws on one of the side panels either the right or left side.

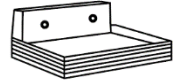

Magazine Rack (optional)

The magazine rack can be screwed on one of the side panels either the right or left side.



Towel Rack (optional)

The towel rack can be screwed on one of the side panels either the right or left side.



(Figure C: Accessories installed inside the sauna)

AUX/MP3 Cable (Provided for specified models only)

The MP3 Auxiliary Socket allows you to connect a MP3 player or radio (with auxiliary out function) to the speakers for your listening pleasure.



Color Therapy Lighting (Provided for specified models only)

Some models will include color therapy lights (or chromo lights) and there are 10-20 colors available. The color lights can be operated by the remote control or the button on the display control panel. Turn on the “Light” button on the display control panel. For K8 models, you can press any color on the remote control to change a color or adjust the brightness. For H6 and J7 models, please press the button on the display control panel to change the colors.

Remote Control for Lighting (depending on different models)

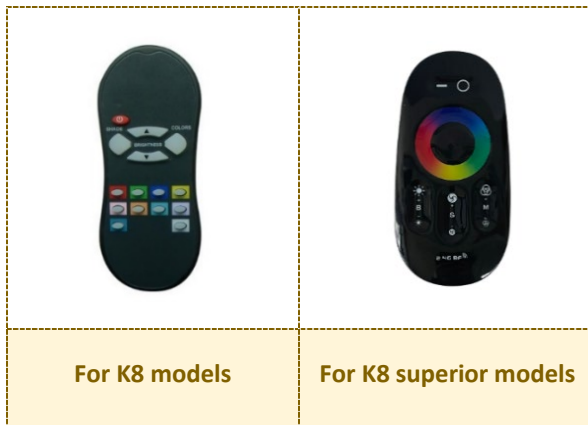

Main Power Switch on the ceiling (For K8 and K8 superior models only)

- Before starting the sauna, please ensure the main power switch is on.
- Utilize the main switch on the ceiling for all emergency situations.



Control Panel Operation Instructions

Please use the instructions below as a reference guide on how to set up the sauna.

Control Panel – Style 1 (For K8 infrared sauna models)

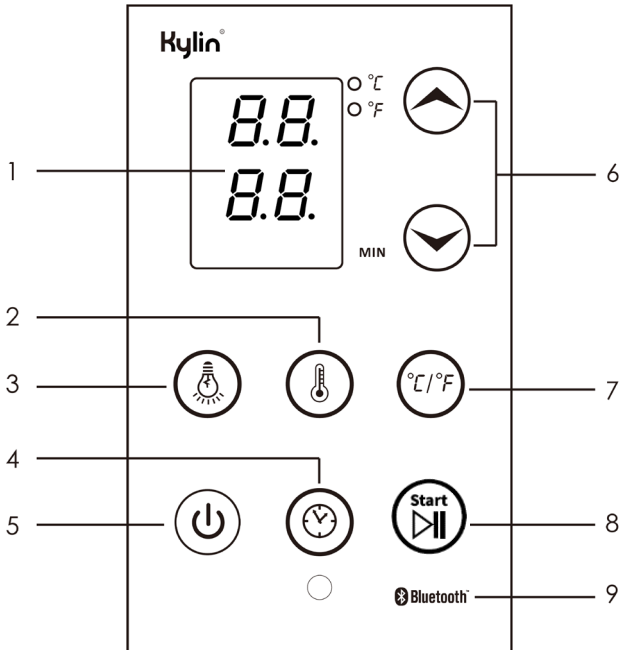

1 Display screen

For temperature and timer display.

2 Temperature button

Press the key to temperature adjustment state.

3 Light button

Press the key to turn on/off the light.

4 Timer button

Press the key to time adjustment state.

5 Power button

Press this key to turn on or turn off the sauna.

6 Adjust button

Press '▲' and '▼' to adjust the temperature setting and the timer setting.

7 Temperature type

Press to change the temperature display between °C/°F.

8 Start/Pause/Play button

After setting the temp or timer, press the button to start the sauna. When music is playing, press this is for pause or play.

9 Bluetooth

Control panel can be connected to devices to play music.

1. Temperature Display Screen

2. Temperature Button

Press the button to change to the temperature setting mode.

3. Light Button

Press the button to turn on/off the light.

**For models with colored lighting function, please use the remote control to change the colors of light.*



4. Timer Button

Press the button to change to the timer setting mode.

5. Power Button

Press the button to turn the sauna on or off.

6. Adjust Button

Use the  or  buttons to increase or decrease the sauna temperature and the sauna timer.

- **Temperature Control**

Adjustment range is 25°C-66°C. Set the temperature and time to a comfortable level, normally, it normally takes around 25-30 mins to heat up. The heaters will keep heating up to reach its desired temperature.

- **Timer Control**

Adjustment range is 5 – 90 mins. When the timer display shows “5”, the timer will beep as a reminder of 5 mins left. When working time reaches the setting time, the sauna will turn off and the heater will stop heating. To extend the sauna session, reset the timer again.

7. Temperature Type (Fahrenheit or Celsius)

These signs indicate what measurement is used to display the temperature. To switch between Fahrenheit and Celsius, press the button.

8. Start/Pause/Play Button

After setting the preferred temperature or timer, press the button to start the sauna. When music is playing, press this button to pause or play the music.

9. Bluetooth

The Bluetooth function for playing music is built into the control panel. First, open your Bluetooth setting on your device. You will find “iSauna” or a similar name and you can pair it with your device. Once pairing is successful, the sauna will make a sound. You can control the volume and choose the music on your device and enjoy the music when having a sauna.

**Only one device can be connected to the sauna at once.*

Control Panel – Style 2

(For H6 infrared sauna models)

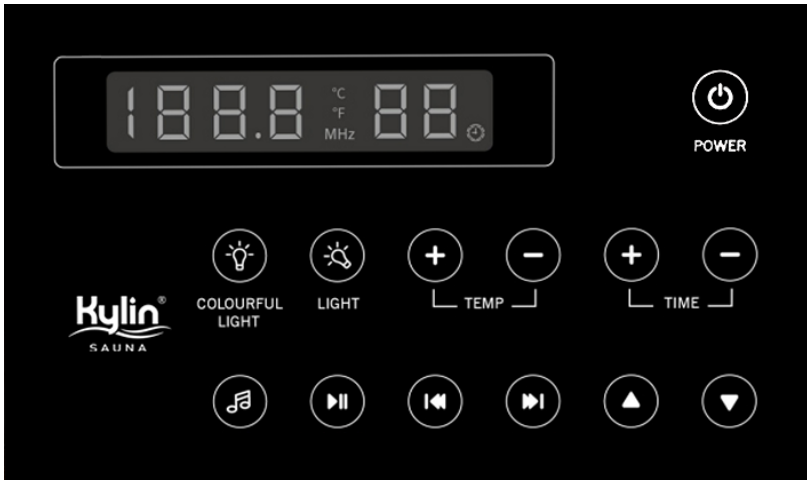

1. Operating panel









Left screen display the temperature inside the room

Right screen shows the remaining time of the timer.

2. LED indicators

- Power indicators
- Heat indicator: heating on the light, off when off.
- F indicator: the temperature displayed is Fahrenheit.
- C indicator: the temperature displayed is Centigrade.

3. Buttons

-  **On/off Button:** Press switch “on/off” .
-  **Light Button:** Light switch. Then press in turn for Full on - Full off
-  **Color Therapy Light Button:** Press once to light on/off.
When the color light is on, hold down the button, the temperature window displays "LX" (X is 1-9), "X" flashes. Then press the button to change the color and state of the light.
-  **Temperature “+/-”** : Adjust temperature. Press the button to increase or decrease the temperature, press and hold it for quick adjusting. Hold down the temperature "+" and "-" keys simultaneously to convert Fahrenheit and Celsius Temperatures.
-  **Time “+” and “-”** : Adjust time. Press the button to increase or decrease the temperature, press and hold it for quick adjusting. Only in "MODE" MODE, press the time "+" and "-" to adjust the volume.
-  **Press “MODE”:** Press it to select the mode of radio, Bluetooth or USB. (Connect Bluetooth by searching the name BT301 to pair with your devices)
-  **Play/Pause** : Under FM mode, hold for 5 seconds to auto-search and save radio frequencies. Press it to select the next frequency. Under BLUE (Bluetooth)/USB mode, press it to select the next song.
-  **Press “MUTE”:** Under FM, press once for mute state. Under BLUE/USB: Press once to pause play.

Control Panel – Style 3

(For J7 infrared sauna models only)



1. Operating panel













Left screen display the temperature inside the room

Right screen shows the remaining time of the timer.

2. LED indicators

- Power indicators
- Heat indicator: heating on the light, off when off.
- F indicator: the temperature displayed is Fahrenheit.
- C indicator: the temperature displayed is Centigrade.

3. Buttons

-  **On/off Button:** Press switch “on/off”.
-  **Light Button:** Light switch. Then press in turn for Full on - Full off
-  **Color Therapy Light Button:** Press once to light on/off.
When the color light is on, hold down the button, the temperature window displays "LX" (X is 1-9), "X" flashes. Then press the button to change the color and state of the light.
- **Temperature**  and  : Adjust temperature. Press the button to increase or decrease the temperature, press and hold it for quick adjusting. Hold down the temperature “<” and “>” keys simultaneously to convert Fahrenheit and Celsius Temperatures.
- **Time**  and  : Adjust time. Press the button to increase or decrease the time, press and hold it for quick adjusting.
Only in "MODE" MODE, press the time  and  to adjust the volume.
-  **Mode:** Press it to select the mode of radio, Bluetooth or USB. (Connect Bluetooth by searching the name BT301 to pair with your devices)
-  **Play/Pause:** Under FM mode, hold for 5 seconds to auto-search and save radio frequencies. Press it to select the next frequency.
Under BLUE (Bluetooth)/USB mode, press it to select the next song.
-  **Mute:** Under FM mode, press it for mute or unmute.
Under BLUE/USB mode, press once to pause play.

Usage Guide

Unlike a traditional sauna, infrared heats the body directly. Air temperature in the sauna is not as important as the type and quality of the infrared being received. We have below suggestions:

1. **Please allow your sauna to warm up for at least 20-30 minutes until it reaches 46-51°C degrees depending on the starting ambient air temperature.** If your sauna is outside, such as in your garage or a patio, you will expect longer heat-up times.
2. When you enter the sauna, set the time to the desired session time and turn the thermostat up to 150+°F / 65°C. This will keep the heaters on the entire time to ensure that you are receiving constant infrared heat.
3. Always start using the sauna within 10°C degrees before it reaches the set temperature in order to receive the most benefits out of the infrared heaters. For example, if you set the sauna to 60°C degrees, you should start using the sauna when it reaches 50°C degrees.
4. Infrared heater warms your body directly, your body will always feel hotter than the temperature shown on the control panel. The temperature sensor only can reflect part of the actual room temperature but not your body temperature.

Tips:

- Please keep the vent closed on the ceiling to speed up the pre-heating process.
- If the sauna becomes stuffy, open the vent on the ceiling to allow fresh air into the sauna.
- It is recommended not to exceed 40 minutes per session.
- Oil and lotions tend to decrease perspiration by blocking pores. Apply these after your session for best results.
- **The appropriate temperature for a sauna depends on your needs or preference. Most of customers prefer an average use temperature of 125°F (52°C) degrees.**

A Reminder when having your sauna

The temperature of the infrared sauna may take a long time to reach the maximum set temperature. This depends on the ambient temperature, humidity, airflow, the frequency of opening and closing doors, etc. However, slowly reaching the maximum set temperature does not affect normal use.

As your body is close to the heaters, your apparent temperature is always higher than the temperature shown on the display. This is because when the sensor attached to the ceiling which is far from the heaters may not reflect the actual set temperature inside the room. The infrared heating panels will continue to heat, and the body temperature will continue to rise. Please keep the vent close just in case there is cold air always coming in.

It is recommended that the infrared cabin is not used within 24 h after UV radiation exposure from artificial sources or sun-bathing; individuals who may be at risk from hyperthermia, such as individuals suffering from cardiovascular disease, should seek medical advice before using infrared warming cabins; when persistent erythema (reddening of the skin lasting more than a day) and netlike colour changes persist after regular exposure to infrared radiation, exposure should not be repeated and medical advice should be sought to prevent the development of erythema ab igne; if you are a person with compromised heat pain sensation or under the influence of alcohol or tranquilizers you should not use infrared warming cabins.

If the supply cord is damaged, it must be replaced by the manufacturer, its service agent or similarly qualified persons in order to avoid a hazard.

Precautions

- Prepare 2-3 towels for maximum comfort. Put one towel on the floor heater but not fully covered to make sure the sweat won't drop into the floor heater continuously.
- Drink liquids prior to and after your session.
- Do not leave the wet towels inside your sauna that could harm the interior of your sauna.
- If the temperature becomes unbearable, decrease the temperature, open the vent or shut off the sauna immediately.
- Do not use it if you are pregnant or have serious inflammation, a fever, a communicable disease, acute bleeding, or when intoxicated.
- Do not consume alcohol or drugs when using the sauna.
- Do not splash water on the heaters or any electrical component inside the sauna.
- All repairs need to be authorized by the Kylin Sauna's representative; otherwise, product warranty may be voided.
- **All controls, heaters, electrical parts, wiring and wood must remain dry and free from exposure to water or liquids. Any wood deformation or wiring damage caused by contact with water (including sweat, rain, or any other liquid) is not covered by the warranty.**



CAUTION, RISK OF FIRE

DO NOT OPERATE THE SAUNA UNSUPERVISED
TO REDUCE THE RISK OF FIRE.

- Avoid contact with liquids on the heating panel.
- Do not cover the heating panel with any combustible material to prevent overheating.
- If the heating panel is deformed or unusual, stop using the sauna immediately and contact the Kylin Sauna team for advice.
- Do not modify the sauna room without permission.

Cleaning and Maintenance

Please use one or two towel placed on the bench and on the floor heater to absorb sweat when using the sauna. Excessive sweating may cause stains on wood and damage to electrical appliances.

Use a clean damp towel to wipe off the bench, floor and around the back panel. Do not use a towel that is too wet and can drip water inside the sauna and do not use cleaning agents inside the sauna.

Make sure to keep the sauna dry and clean. Do not leave towels or water glasses or bottles inside the sauna after use. Wipe the exterior surface of the sauna with a towel and clean the glass at least once a month.

Wood Care

In general, it is suggested to place a towel on the bench and a floor mat on the floor to protect the wood surfaces from dirt, sweat, and wear.

For indoor models, clean the interior and exterior of the sauna with a small amount of wood cleaner and water solution as needed and allow it to dry completely. Optionally, you can apply furniture polish on the exterior wood to help maintain its appearance and protect it from minor scratches or scuffs. Please avoid any treatment containing benzene or a high concentration of alcohol.

The body of outdoor models needs to be maintained on a regular bases (Once every 6 months to a year) by polishing or resealing the body as needed. If the varnish is cracked or worn off, sand the surface and re-varnish the affected area.

Your Kylin sauna is made of the Canadian Hemlock Wood. All wood products may have variations in the color, grain, and may have irregularities such as knots, and fine cracks. These reflect the natural beauty of the wood and should not be considered defects.

The wood must be kept dry. If the wood is deformed or damaged due to contact with water (including sweat, rain and any other liquid), it is not covered by the warranty.

Sauna Benefits

Health Benefits

Detoxification and Body Cleansing

Detoxification is a bodily process that transforms health threatening toxic substances from our environment, diets, as well as our own bodies into something harmless or excreted. Sweat is the body's natural way to get rid of harmful toxins and cleansing our bodies through the skin. The infrared sauna waves penetrate deep below the skin to help the body to get rid of toxins buried deep under the skin.

Weight Loss

Saunas are proven to help lose weight and burn calories. According to the Journal of the American Medical Association, a sauna session can burn between 300-700 calories. This finding was also backed by Dr Oz's explanation of infrared saunas during a segment of the Oprah Winfrey show.

Pain and Arthritis Relief

The Saunas infrared waves penetrate deep into the muscles for long lasting pain relief. Moreover, patients with rheumatoid arthritis will benefit in the alleviation of short-term pain, stiffness and reduced fatigue.

Skin Purification

During a sauna session, skin is cleansed and dead cells are replaced, keeping the skin in good working condition. Sauna heat also relaxes facial tensions, and improves skin elasticity. The process of sweating also rinses bacteria out of the epidermal layer and sweat ducts.

Cardiovascular Workout

Finnish researchers have reported that the regular use of saunas helps maintain the blood vessels in a healthier condition. Vessels become more extended, elastic and pliable due to regular dilation and contraction from the process of heating and cooling the body repeatedly.

Lower Blood Pressure and Improved Circulation

Blood vessel dilation brings blood closer to the surface of the skin and as blood vessels expand to accommodate increased blood flow, circulation in the extremities improves, and as a result the blood pressure becomes lower. The effect on the blood pressure is temporary, but medical research shows that frequent sauna bathing can make person's blood pressure level stay lower as well.

DISCLAIMER:

The Sauna and its affiliate is to be not treated as medical advice, education or treatment. The information contained in this manual is for general information purposes only and does not address individual circumstances or medical conditions. Suitability will vary person to person and the information provided in this manual should not be relied solely upon in making decisions about your health. Always consult your doctor for medical advice.

Saunas and Contraindications

Saunas and Medications

Individuals who are using prescription drugs should seek the advice of their personal physician or a pharmacist for possible changes in the drugs effect when the body is exposed to far infrared waves or elevated body temperatures. Diuretics, barbiturates and beta-blockers may impair the body's natural heat loss mechanisms. Some over the counter drugs such as antihistamines may also cause the body to be more prone to heat stroke.

Saunas and Children

The core body temperature of children rises much faster than adults. This occurs due to a higher metabolic rate per body mass, limited circulatory adaptation to increased cardiac demands and the inability to regulate body temperature by sweating. Consult with your child's pediatrician before allowing your child to use the sauna.

Saunas and the Elderly

The ability to maintain core body temperature decreases with age. This is primarily due to circulatory conditions and decreased sweat gland function. The body must be able to activate its natural cooling processes in order to maintain core body temperature.

Saunas and Cardiovascular Conditions

Individuals with cardiovascular conditions or problems (hypertension / hypotension), congestive heart failure, impaired coronary circulation or those who are taking medications, which might affect blood pressure, should exercise extreme caution when exposed to prolonged heat. Heat stress increases cardiac output, blood flow and in an effort to transfer internal body heat to the outside environment via the skin (perspiration) and respiratory system. This takes place primarily due to major changes in the heart rate, which has the potential to increase by thirty (30) beats per minute for each degree increase in core body temperature.

Saunas and Alcohol

Contrary to popular belief, it is not advisable to attempt to "Sweat Out" a hangover. Alcohol intoxication decreases a person's judgment; therefore, a person may not realise it when the body has a negative reaction to high heat. Alcohol also increases the heart rate, which may be further increased by heat stress.

Saunas and Chronic Conditions / Diseases Associated with a Reduced Ability to Sweat or Perspire

Parkinson's, Multiple Sclerosis, Central Nervous System Tumors and Diabetes with Neuropathy are conditions that are associated with impaired sweating.

Saunas and Hemophiliacs / Individuals Prone to Bleeding

The use of Infrared saunas should be avoided by anyone who is predisposed to bleeding.

Saunas and Fever

An individual that has a fever should not use any type of sauna.

Saunas and Insensitivity to Heat

An individual that has insensitivity to heat should not use any type of sauna.

Saunas and Pregnancy

Pregnant women should consult a physician before using any type of sauna because fetal damage can occur with a certain elevated body temperature.

Saunas and Menstruation

Heating of the low back area of women during the menstrual period may temporarily increase a woman's menstrual flow. Some women endure this process to gain the pain relief commonly associated with their cycle whereas others simply choose to avoid saunas use during this time of the month.

Saunas and Joint Injury

If you have a recent (acute) joint injury, it should not be heated for the first 48 hours after an injury or until the hot and swollen symptoms subside. If you have a joint or joints that are chronically hot and swollen, these joints may respond poorly to vigorous heating of any kind. Vigorous heating is strictly contraindicated in cases of enclosed infections be they dental, in joints or in any other tissues.

Saunas and Implants

Metal pins, rods, artificial joints or any other surgical implants generally reflect far infrared waves and thus are not heated by this system; nevertheless, you should consult your surgeon prior to using an Infrared Sauna. Certainly, the usage of an Infrared Sauna must be discontinued if you experience pain near any such implants. Silicone does absorb far infrared energy. Implanted silicone or silicone prostheses for nose or ear replacement may be warmed by the far infrared waves. Since silicone melts at over 200°C (392°F), it should not be adversely affected by the usage of Infrared saunas. It is still advised that you check with your surgeon and possibly a representative from the implant manufacturer to be certain.

In the rare event you experience pain and/or discomfort, immediately discontinue to use the sauna.

Troubleshooting

The sauna doesn't power on

- Make sure the power cord is securely connected to the power socket and the control box (on top of the sauna).
- Make sure the breaker did not turn off.
- Make sure the control panel white ribbon wire is securely connected.
- Make sure the power socket is working by trying a different device on the same socket.

Light is not working

- Try reconnecting the light connector and make sure the connection is well.
- Try replacing the light bulb.

Colour therapy light does not work

- Make sure the battery is inserted correctly on the remote control (if provided)
- Make sure to point the remote directly at the display control screen.
- Try a new battery.

All heaters are not working

- Make sure the heater plugs are connected securely to the control box (on top of the sauna).
- Make sure the sauna is connected to the recommended power supply.
- Make sure the heat sensor is connected securely.

One or few heaters are not working

- Make sure the heater plugs are connected securely to the control box (on top of the sauna).
- Make sure the heater plugs under the bench are connected securely.
- Floor heaters and under bench heaters are not as hot as other heaters (It's normal by design due to the different watts distribution).

- Make sure the plug behind the heater is connected (you would need to unscrew the heater).

ER1 error code occurs

An ER1 error code indicates an open circuit. This means there is a break in the path of the electrical current, preventing it from flowing through the circuit.

- Switch off the power supply before working on the circuit.
- Inspect the circuit path to locate the disconnected part.
- Repair or replace the disconnected part, ensuring the circuit is well connected.

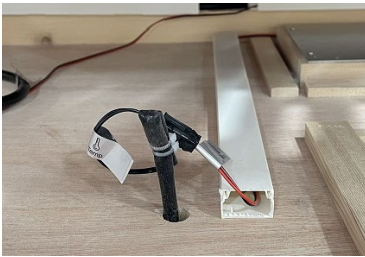

Check the temp sensor

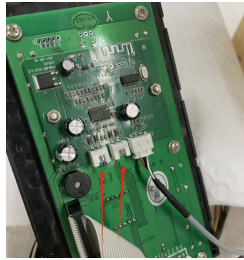

Check the wires behind
the control panel



Check the plugs

ER2 error code occurs

An ER2 error code indicates a short circuit. This means faulty wiring or improper connections between two points in an electrical circuit.

- Switch off the power supply before working on the circuit.
- Check the power supply is only for the sauna itself
- Check if the fuse inside the main electrical box (on the roof panel) is broken or burnt.
- Reconnect or replace any broken wires, components, or connectors.
- Ensure all connections are secure and components are in good condition.

Change the carbon heater

1. Removing the screws around the wooden frame, unplug the connector, then removing the broken carbon heater.
2. Change the new carbon heater, plug the connector, and screw the wooden frame on the sauna panel.

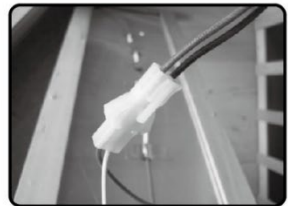

For more troubleshooting advice or to report a problem, please contact the Kylin Sauna support team at contact@kylinaustralia.com.au.

Warranty Information

The Sauna guarantees its products to be free of defects in material and workmanship.

Type	Purpose	Structural	Parts	Labor
Infrared Sauna	Residential	5 Years	5 Years	1 Year
	Commercial	1 Year	1 Year	6 Months
Traditional Sauna	Residential	5 Years	2 Years	1 Year
	Commercial	1 Year	1 Year	6 Months

This warranty extends only to:

1. a retail purchaser of a sauna or parts directly from Kylin Sauna;
2. the authorised wholesale purchaser of a sauna or parts directly from Kylin Sauna; or
3. a retail purchaser of a sauna or parts from Kylin Sauna

However, in the event of a sale, transfer or conveyance of a sauna or parts from any of the three (3) proceeding persons or entities, any rights, duties and obligations associated with this warranty shall be null and void and of no further force and effect. The sauna or parts must be purchased and used within one year of the purchased date.

The sauna or parts must be placed in an indoor environment unless the sauna or parts are specifically designed for outdoor use. If an indoor sauna or parts are placed in an outdoor environment, warranty shall be null and void and of no further force and effect. The controls, heaters, electrical parts and wiring must be kept dry at all times and not exposed to any water or liquids. If the wood is deformed or damaged due to contact with water (including sweat, rain and any other liquid), it is not covered by the warranty.

Labour Warranty

Customers within **free service area** will enjoy free 1-year labour service for residential use and 3 months for commercial use. An extra call out fee is required after the warranty period and/or out of our service area. **Free on-stie service area is within 45 km from Blackburn VIC 3130, Hurstville NSW 2220 and Seventeen Mile Rocks QLD 4073.**

The warranty begins on the original date of purchase, and is valid only on products purchased and used in the pointed market. To receive warranty service, the purchaser must contact the Kylin Sauna to determine the problem and service procedures. Warranty service can only be performed by the Kylin Sauna authorised service center. The original dated bill of sale must be presented upon request as proof of purchase to the Kylin Sauna or the Kylin Sauna authorised service center.

In-home service will be provided during the warranty labour period subject to availability within the eligible area in Australia. In-home service is not available in all areas. To receive in-home service, the product must be unobstructed and accessible from floor level to service personnel. If during in-home service repair cannot be completed, it may be necessary to remove, repair and return the product. If in-home service is unavailable, the Kylin Sauna may elect, at our option, to provide for transportation of our choice to and from the Kylin Sauna authorised service center. Otherwise, transportation to and from the Kylin Sauna authorised service center is the responsibility of the purchaser.

This warranty covers manufacturing defects in materials and workmanship encountered in normal use of this product, and shall not apply to the following, including, but not limited to: damage which occurs in shipment; delivery and installation; applications and uses for which this product was not intended; altered product or serial numbers; cosmetic damage or exterior finish; accidents, abuse, neglect, fire, water, lightning or other acts of nature; use of products, equipment, systems, utilities, services, parts, supplies, accessories, applications, installations, repairs, external plumbing and leaks, external wiring, circuit breakers, fuses or connectors not supplied and authorised by the Kylin Sauna, or which damage this product or result in service problems; incorrect electrical line

voltage, fluctuations, and surges; customer adjustments and failure to follow operating instructions, cleaning, maintenance and environmental instructions that are covered and prescribed in the instruction book; consumable items including light bulbs.

The Sauna shall not be liable for the loss of use of the sauna or other incidental or consequential damages. Under no circumstances shall the Kylin Sauna or any of its representatives be held liable for injury to any person or damages to any properties. Specifications are subject to change without notice.

The sauna uses the highest quality wood in our product lines. All structures using wood are susceptible to minor dents, scratches and scuffing. This is normal and will not affect the integrity or operation of your sauna.

Wood is a living material that continues to respond to climate conditions, even after being manufactured into a sauna. Variations in the color or grain, and irregularities such as fine cracks are part of the natural beauty of the wood and in no way should be considered defects. During normal operation, wood may crack slightly due to the changes in moisture level. This will not affect the structural integrity of the sauna.

Prior to shipping, the wood is inspected for consistency, colour and quality. Our saunas are shipped around the globe, and can experience slight blemishes, scratches or scuffs in transit. In most cases, these blemishes on the exterior of the sauna can be concealed by using a small amount of furniture polish, oil or other furniture treatment. The interior blemishes, scratches, or scuffs can be either left alone, sanded or a combination of gluing plus sanding. Please avoid any treatment containing benzene or a high concentration of alcohol.

Delivery

Please accept your sauna may be shipped by separate parcels or pallets because of the specified allocation from carrier.

If the Buyer, or a representative of the Buyer, is not present to accept delivery at the time and place indicated by the carrier, the sauna will be left in a safe place,

or the Buyer may be liable for costs of storage and re-delivery of the sauna and such costs will be payable prior to the re-delivery of the sauna.

ATTENTION: Kylin Sauna must be notified of any damage to your sauna **within two (2) business days** of signing the proof of delivery. Failure to notify Kylin Sauna support team within the established time frame will result in the owner taking full responsibility for cost of All Replacement Parts including shipping and handling fees.

Cancellation

If an order is cancelled by the Buyer prior to dispatch of the sauna, all monies paid by the Buyer for that order will be refunded, a cancellation fee may be payable by the Buyer.

If a cancellation is made after the sauna has been shipped, then the buyer will be responsible for both way shipping charges.

Return & Refund

If the sauna purchased are and you're not completely satisfied, please contact us at 1300 790 806 or email us at contact@kylinaustralia.com.au. Our experts will assist you and provide with the best solution for you.

Any return or refund request should be within 30 days of the shipping date to get an approval authorization. For change of mind return, the returned sauna must be unused, undamaged, in a good condition with packing materials, along with the shipping pallet. The only exception for return and refund is for units determined by Kylin Sauna to have a defect in materials and/or workmanship beyond repair.

Kylin may refuse to refund all or any portion of payment if buyer fails to fully comply with or violates the terms and conditions of this policy. All returns may be subject to a restocking fee of 20% of valued price.

Keep in mind that the condition of the item sent back is important, please help to repack it carefully. If you return the item used, damaged, missing parts, or damaged during return shipping because it wasn't packaged correctly, Kylin may deduct from the refund to cover the loss in the item's value.

Once the item is delivered to us, your refund should be processed within 2 business days. Your refund will be sent to your original payment method and funds are usually available within 3-5 business days.

Legal Rights

In Australia our goods come with guarantees that cannot be excluded under the Australian Consumer Law. You are entitled to a replacement or refund for a major failure and for compensation for any other reasonably foreseeable loss or damage. You are also entitled to have the goods repaired or replaced if the goods fail to be of acceptable quality and the failure does not amount to a major failure. So, as well as your statutory rights referred to above and any other rights and remedies you may have under any other laws relating to your Kylin product, we also provide you with Kylin warranty. It's important to note that this warranty is valid only in the country of purchase.

And if for any reason you wish to contact us, please do so at:

Kylin Customer Service Australia 1300 790 806



Kylin[®]
SAUNA

- 📞 1300 790 806
- 🌐 kylinaustralia.com.au
- 🏠 12/11 Mary St Blackburn VIC 3130